

T-110 series is the world's smallest CO₂ sensor module. Its Persistent Stability and Temperature Effect Resistance besides easy management are much favored by customers in HVAC, scientific projects, etc.

T-110L-3V is much favored by customers whose application needs 3.3Voltage input and sleep mode support so on.

ELT Sensor Data Sheet for T-110L-3V

Features

- Non-Dispersive Infrared (NDIR) technology used to measure CO₂ levels.
- The world's smallest size
- Pre-calibrated
- Available output : TTL-UART, I2C
(PWM/Analog Voltage option)
- Gold-plated sensor provides long-term calibration stability.
- Installed Calibration function
- ACDL (Periodical Automatic Calibration) and MCDL (Non-Periodical Manual Calibration) are available..
- ROHS Directive : 2011/65/EU
[EN 50581 : 2012, IEC 62321-3-1 : 2013]
- Size : 19mmx29.3mmx8.5mm
- Weight : 5 grams

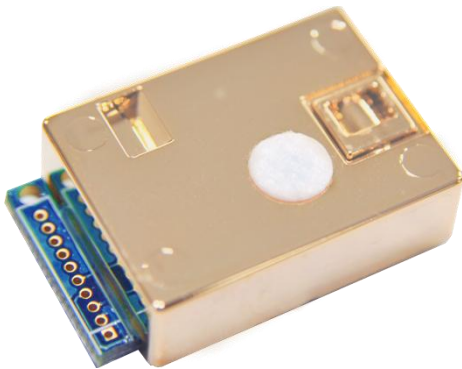

T-110L-3V Specifications

General Performance

Operating Temperature : 0°C ~ 50°C

Operating Humidity : 0 ~ 95% RH (Non-condensing)

Operating Environment : Residential, Commercial spaces

Storage Temperature : -30°C ~70°C

CO₂ Measurement

Sensing Method : NDIR (Non-dispersive Infrared)

Measurement Range : 400 ~ 2,000 (3,000/5,000/10,000ppm, 2%/3%/5%/10% models are available)

Accuracy : ± 50ppm ± 3%of reading ⁽³⁾⁽²⁾ (±300ppm ±3% of reading - 2%/3%/5%/10% models)

Response Time(1/e) : 90 seconds

Signal Update : 5 seconds

Warming-up Time : < 25 seconds (5 minutes for Accuracy)

Electrical Data

Power Input : 3.2V ~ 3.55V⁽³⁾

Current Consumption: Normal mode : 12mA, Peak : 180mA, Sleep: 0.3mA⁽⁴⁾

Product Derivatives with Functions

Products	Option List
T-110-3V	UART,I2C, AVO(PWM option), ACDL, 10'MCDL, 10pin-Connector
T-110L-3V (Low Power)	Sleep mode is added on T-110, which consume < 0.3mA
T-110G-3V (99% Humidity)	Resistance up to 99% Humidity is added on T-110, for Application of bathroom
T-110A-3V	Operate as ACDL always as software unless 10' MCDL is on,

⁽¹⁾ IAQ application, accuracy is defined after minimum 3 times calibration for 3 weeks.

⁽²⁾ +/- 2% is added for absolute measurements for uncertainty of calibration gas mixture unless the measurement is done with certified calibration mixtures.

⁽³⁾ DC Supply should be regulated, low noise power source for best accuracy.,

⁽⁴⁾ 'L' option : < 0.3mA of Low Power Consumption model

ELT SENSOR Corp.

There are 3 derivatives which has additional function on T-110-3V, T-110L-3V is Low Power model, consumes less than 0.3mA in Sleep mode while as T-110G-3V is hardware-enforced one to be resistant to endure up to 99% humidity for customers whose application is Greenhouse and Stock Raising, and T-110A-3V is supposed to operate with software based ACDL as default.

Pin Map of J1 Side hole.

Pin No.	T-110L-3V	T-110L-3V (AVO or PWM Option)
1	VDD (+3.3V VCC)	
2	GND	
3	TTL-RXD(← CPU of Master Board)	
4	Reserved	PWM (Pulse Width Modulation) (Option)
5	TTL-TXD(← CPU of Master Board)	
6	ACDL(Automatic Calibration)	
7	Reserved	Analog Voltage Output (Option)
8	I2C SCL	
9	I2C SDA	
10	MCDL(10 min. Manual Calibration)	

UART

38,400BPS, 8bit, No parity, 1 stop bit, TTL Level Voltage (for inspection use)

I2C (J-12:P3&P4)

Slave mode only (* SCL and SDA should be added 10kΩ external pull up resistor each.)

TTL Level Voltage : $0 \leq V_{IL} \leq 0.4$, $2 \leq V_{IH} \leq V_{DD}$, $0 \leq V_{OL} \leq 0.4$, $2.4 \leq V_{OH} \leq V_{DD}$ (Volt)

Analog Voltage (0.5~3.0V) : Option

CO2 Measurement_(ppm) = $\text{Output Voltage} - 0.5 / (3.0 - 0.5)_{\text{Voltage}} \times \text{F.S.}_{\text{ppm}}$,

Digital to Analog Conversion Error : < 0.5%

PWM Output : Option.

$t_H = 2 \text{ msec}(\text{Start}) + 1,000 \text{ msec} \times (\text{Measurement}_{\text{(ppm)}} / \text{Range}_{\text{(ppm)}})$,

$t_L = 2,000 \text{ ppm} - t_H$, (Period : 2,000 ppm)

ELT SENSOR Corp.

Status Table of T-110L-3V J1 Side Hole.

Pin-6	Pin-10	Status	Notes
Low	High	H/W ACDL	Calibrate weekly after 2 days since power-on
High	High	Normal	Operate with Pre-calibrated value in Factory or previous state.
High	Low	H/W MCDL	Manual Recalibration– sensor should be located in 400ppm environment (outside) for 10 minutes and ‘Low’ signal to pin 10 should be done no later than 18 minutes.

※ The setting of Pin-6 ‘Low’ and pin-10 ‘Low’ shouldn’t be used at any time.

Pin Map of J2 Board to Board Connector.

Pin No.	T-110L-3V	T-110L-3V (PWM or Analog Option)
1/16	VDD (+3.3V VCC)	
2/8/9/12	GND	
3	Reset (Active High)	
4	Reserved	
5	I2C SCL	
6	ACDL (Automatic Calibration)	
7	PWM Output option	
10	Analog Voltage Output option	
11	MCDL (10 min. Manual Calibration)	
13	TTL RXD (← CPU of Master Board)	
14	TTL TXD (→ CPU of Master Board)	
15	I2C SDA	

※ B-to-B Connector mating should be enhanced with additional Locking method.

Status Table of T-110L-3V J2 Board-To-Board Connector

Pin-6	Pin-11	Status	Notes
Low	High	H/W ACDL	Calibrate weekly after 2 days since power-on
High	High	Normal	Operate with Pre-calibrated value in Factory or previous state.
High	Low	H/W MCDL	Manual Recalibration– sensor should be located in 400ppm environment (outside) for 10 minutes and ‘Low’ signal to pin 10 should be done no later than 18 minutes.

※ The setting that both Pin-6 and pin-11 get ‘Low’ signal should be avoid at any time.

Cavity Dimensions (unit : mm)

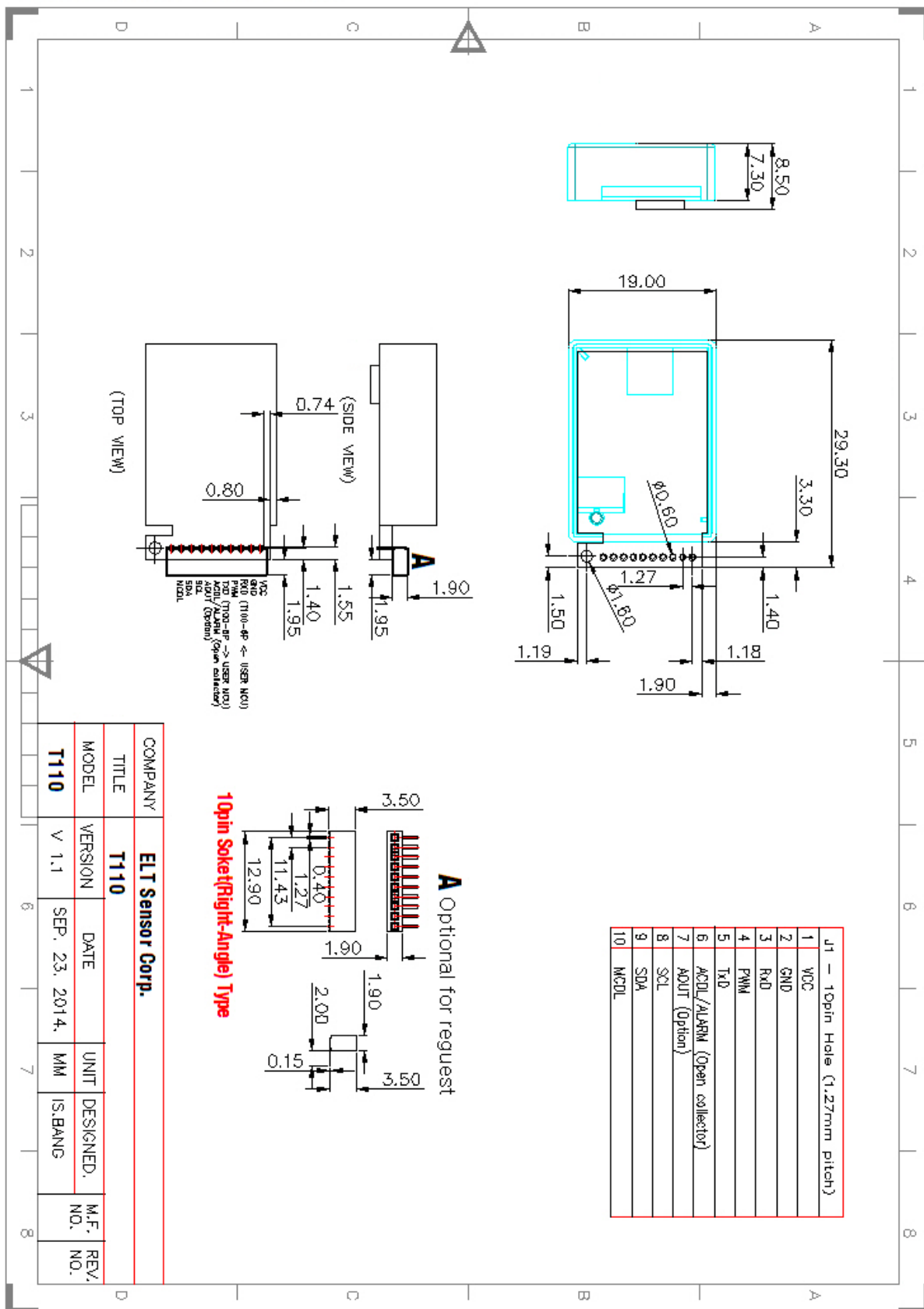

ELT SENSOR Corp.

1.27mm pitch socket is recommended for T-110L-3V for convenience of connection.(Optional)

RevNo	Revision note	Date	Signature Checked
--------------	----------------------	-------------	--------------------------

0.4
1.27 ±0.1 Pitch
10.16 ±0.2
11.63 ±0.2

1.9 ±0.2
2.0 ±0.2
0.15
3.5 ±0.2

1.9
1.27 Pitch

PRINTED CIRCUIT BOARD LAYOUT
∅0.8 ±0.1
1.27 Pitch

NOTE

1. HOUSING MATERIAL : THERMOPLASTIC.
- COLOR : BLACK
2. PIN MATERIAL : P-Bronze
- FINISH : Gold Flash
3. Number of Position : 0.2 ~ 50

Designed by KKH	Checked by	Approved by - date	File name	Date	Scale
			1.27mm Socket	09/1/19	S:1
DONGSHIN SEMICOM				BS127S-R035-nnG	Edition 0
				Sheet 1/1	

And 1.27mm center pin header recommended for mating with Socket of T-110L-3V.

1.27mm Pitch Pin Header(PH15 Series)

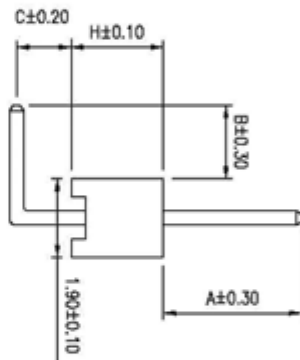
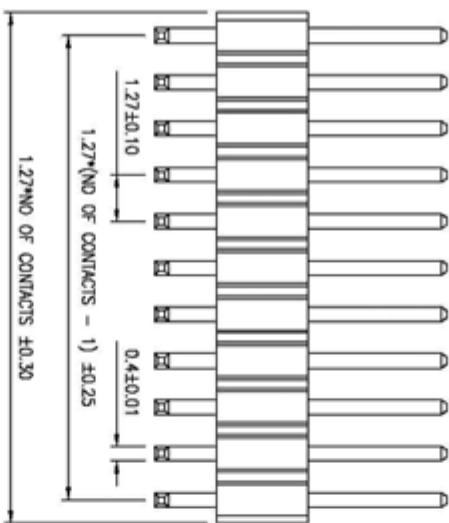

SPECIFICATION

- Current Rating: 1 A
- Withstanding Voltage: 600 VAC (1 min.)
- Insulation Resistance: 1000 Megohms MIN.
- Contact Resistance: 30 Milliohms MAX.
- Operating Temperature: -40°C to +85°C
- Retention Force: 450g MIN.

MATERIAL

- Contact: Phosphor Bronze , 0.40mm square post
- Insulator: NYLON 66 & 30% G.F.
- Plating: Selective Gold or All Gold

Base Height

Base	H
1	1.00
2	1.50
3	2.00
4	2.40
5	3.00

Pin Chart

Pin	A	B	C
1	2.50	1.50	1.00
2			
3			
4			
5			

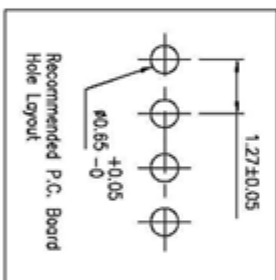

0.0±		SCALE:	TITLE:		PART NO.:	
0.00±		UNIT: MM	1.27MM CENTER PIN HEADER		APP BY:	
0.000±			0.40mm/m R/A single Row		CHK BY:	
		MATL: NYLON 66 + 30% GF	DWG. NO. HW02		DR BY:	

ELEPARTS Co.,Ltd

REV	ECN NO.	APP.	DATE
A	NEW DESIGN		

Dimensions unit : mm

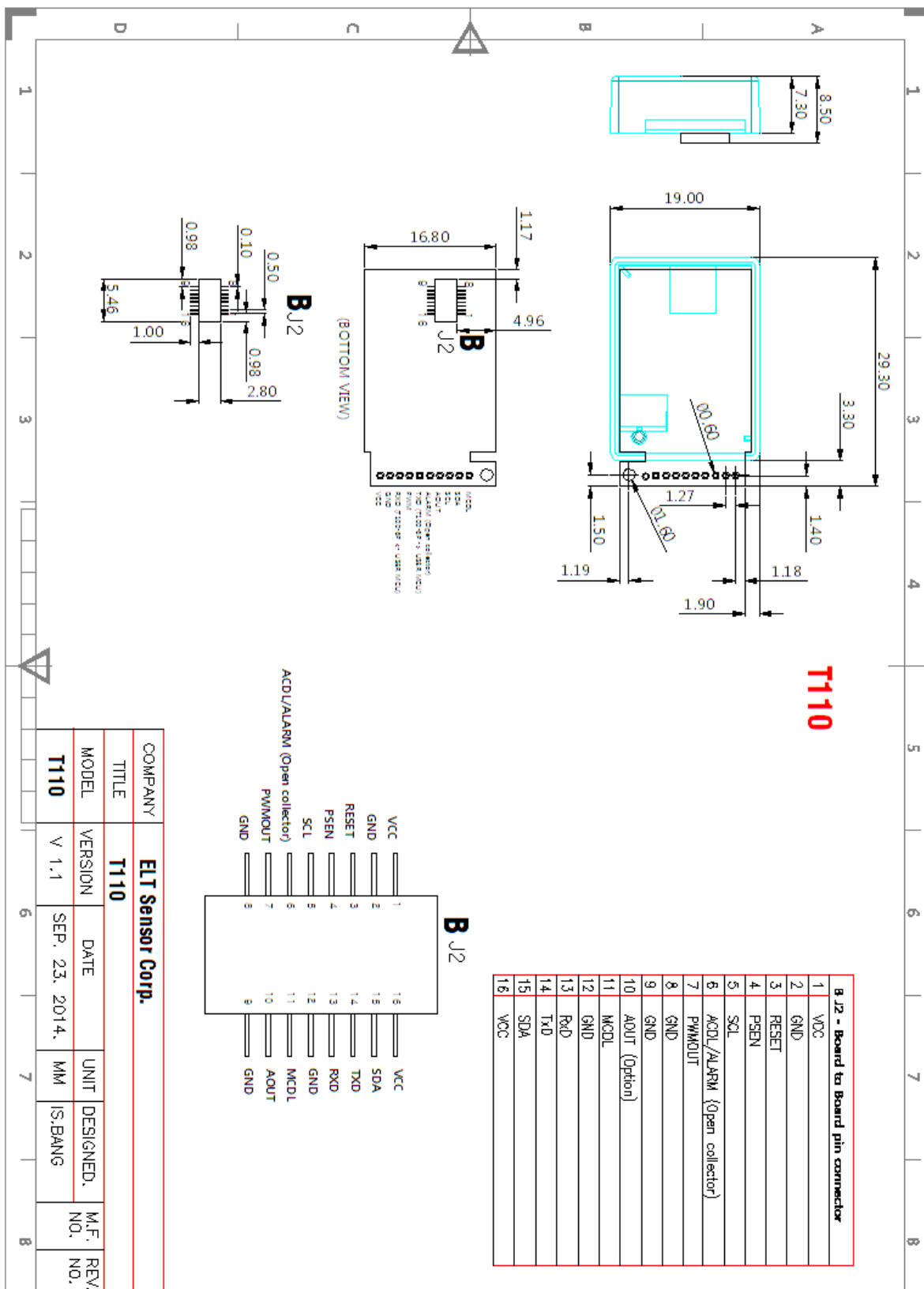

T-110L-3V has B-TO-B connecting PLUG (Molex: 55560-0168)on PCB.

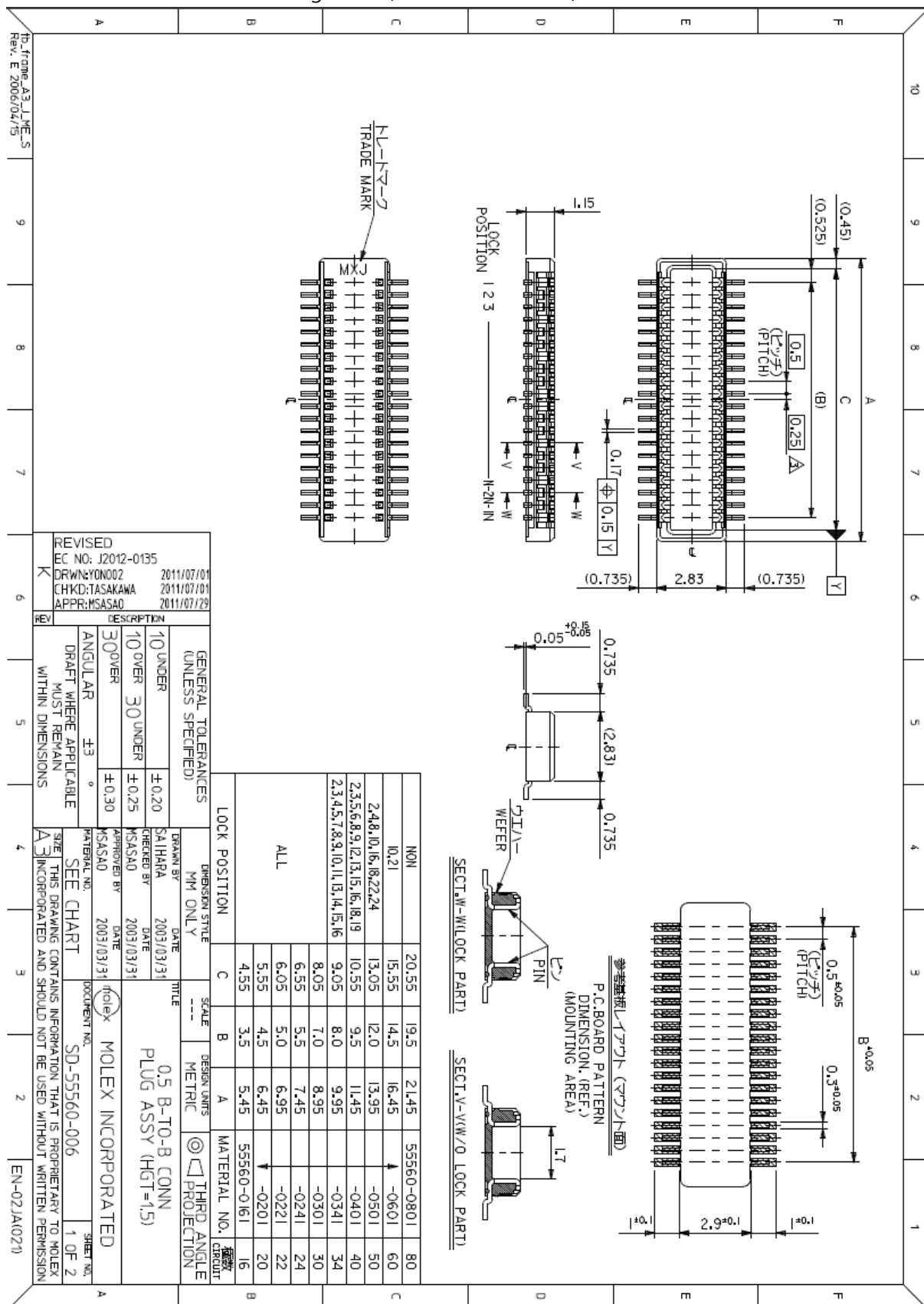

Dr. frame: A3, JME-S
Rev. E 2006/02/15

REVISED	EC NO. J2012-0135
DRWN: YON002	2011/07/01
CHKD: TASAKAWA	2011/07/01
APPR: MSASAO	2011/07/29

DESCRIPTION	
GENERAL TOLERANCES (UNLESS SPECIFIED)	
10 UNDER	±0.20
10 OVER	±0.25
30 OVER	±0.30
ANGULAR	±3°
DRAFT WHERE APPLICABLE MUST REMAIN WITHIN DIMENSIONS	

LOCK POSITION	
MM ONLY	SCALE
DESIGN UNITS	METRIC
MATERIAL NO.	55560-0161
CIRCUIT	16
DESIGN STYLE	---
THIRD ANGLE PROJECTION	
DESIGN BY	SAIHARA
DATE	2003/03/31
TITLE	0.5 B-TO-B CONN PLUG ASSY (HGT=1.5)
CHECKED BY	MSASAO
DATE	2003/03/31
APPROVED BY	MSASAO
DATE	2003/03/31
DOCUMENT NO.	SD-55560-006
SHEET NO.	1 OF 2

EN-021A(021)

And mating B-TO-B Receptacle (**Molex: 54722-0164**) should be on Main PCB. Mating Receptacle with PLUG should be done very carefully. Only the gripping of side plane of T-110L-3V is allowed while as pressing on Top plane or Bottom of T-110L-3V is strictly restricted. Additional enforcement besides B-TO-B connection against vibration or dropping Fixing hole is available on the next of Side holes as the additional enforcement with alignment pin of main-board, Double sided Tape could be used for stable mating between B-TO-B Receptacle and PLUG.

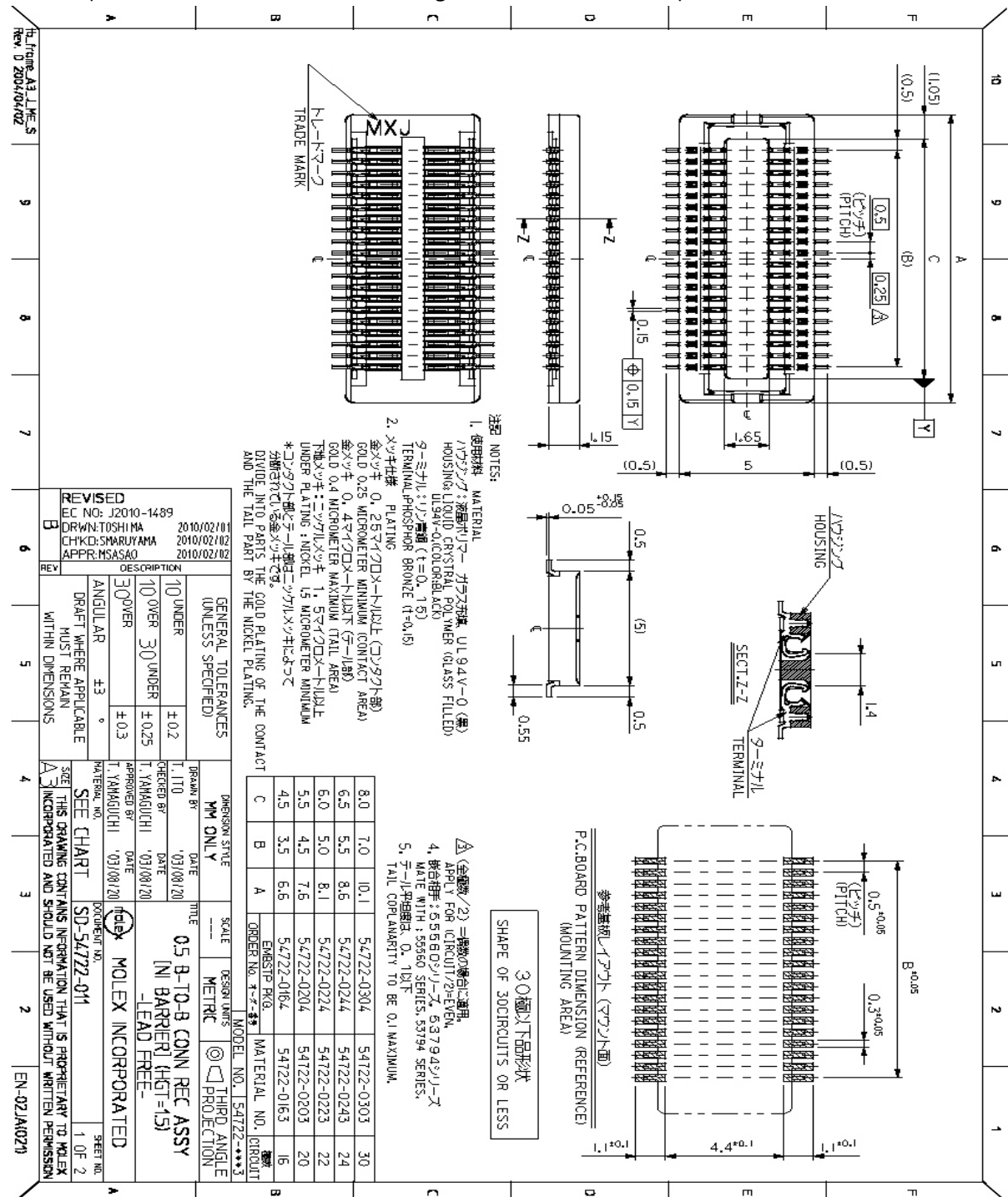

REV	DESCRIPTION	DATE	BY
B	REVISION	2010/02/10	T. YAMAGUCHI
	EC NO: J2010-1489	2010/02/10	T. YAMAGUCHI
	DRWN: TOSHIMA	2010/02/10	T. YAMAGUCHI
	CHKD: SHIRUYAMA	2010/02/10	T. YAMAGUCHI
	APPR: MSASAO	2010/02/10	T. YAMAGUCHI

GENERAL TOLERANCES (UNLESS SPECIFIED)	ANGULAR	SCALE
10 UNDER ±0.2	±3°	METRIC
10 OVER ±0.25	0	THIRD ANGLE PROJECTION
30 OVER ±0.3		

DESIGN STYLE	DATE	TITLE
MM ONLY	03/08/20	05 B-TO-B CONN REC ASSY
DESIGNED BY	DATE	IN BARRIER (HGT=15)
T. YAMAGUCHI	03/08/20	LEAD FREE
CHECKED BY	DATE	
T. YAMAGUCHI	03/08/20	
APPROVED BY	DATE	
T. YAMAGUCHI	03/08/20	

MODEL NO. 154722-***3
 ORDER NO. *-*-*
 MATERIAL NO. (CIRCUIT)

SEE CHART SD-54722-011
 SEE CHART SD-54722-011
 INCORPORATED AND SHOULD NOT BE USED WITHOUT WRITTEN PERMISSION

MOLEX INCORPORATED

SHEET NO. 1 OF 2

Rev. 0 2004/04/02

EN-02JA0270

ACDL function(Automatic Calibration Function in Dimming light with period)

※ T-110L-3V: ACDL is executed only when sensor is kept during the period except for sleep mode.

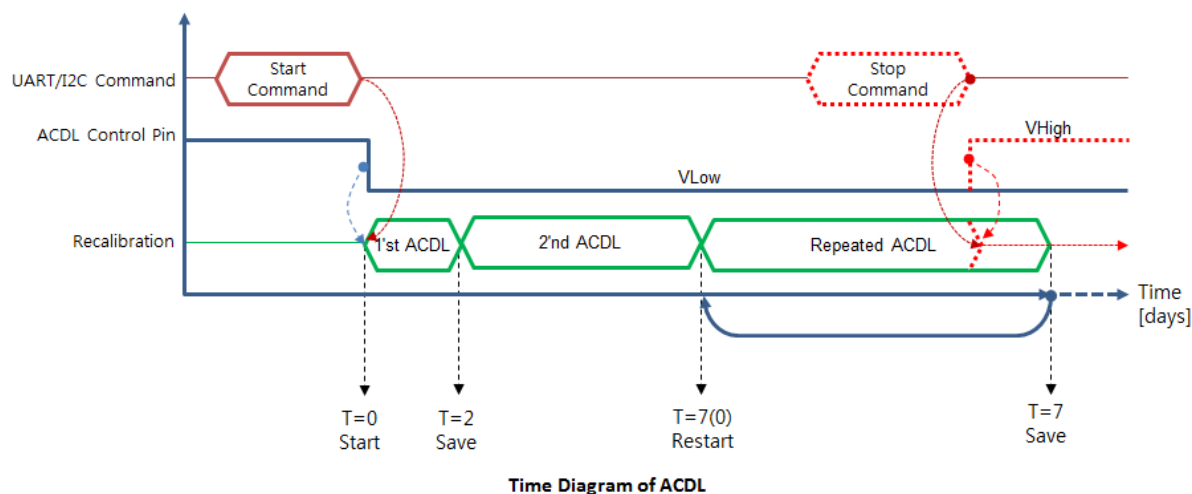

Method 1. UART Command Set; J1-3pin (UART-RX) and J1-5pin (UART-TX) to Main-Board.
(J2-13pin and J2-14pin are available for BtoB connector User as well)

Method 2. I2C Command Set; J1-8pin (SCL) and J1-9pin (SDA) to Main-Board.

Method 3. Execute Hardware based ACDL.

- ※ 1. To activate ACDL function, the user's application must be designed to give Low-Active Signal to J1-6pin with High De-Active Signal to J1-10pin continuously.
(J2-6pin and J2-11pin are available for BtoB connector User as well)

- 2. T-110A has ACDL software in sensor, which make sensor always operate as ACDL unless MCDL is activated.

Method 4. Let Sensor install on Jig Board TRB-100ST (Test and Recalibration Board) with ambient air-flow condition and execute by moving jumper with Manual on the website.

Method 5. EK-100TL (Emulation kit, with Emulation program 'ELTWSD') is available, which display and save data on PC through USB connection.

MCDL function(Manual Calibration Function in Dimming light).

※ T-110L-3V : MCDL-command or MCDL-Control signal make reserve MCDL function, which takes 25 seconds, just after the next Reading is finished.

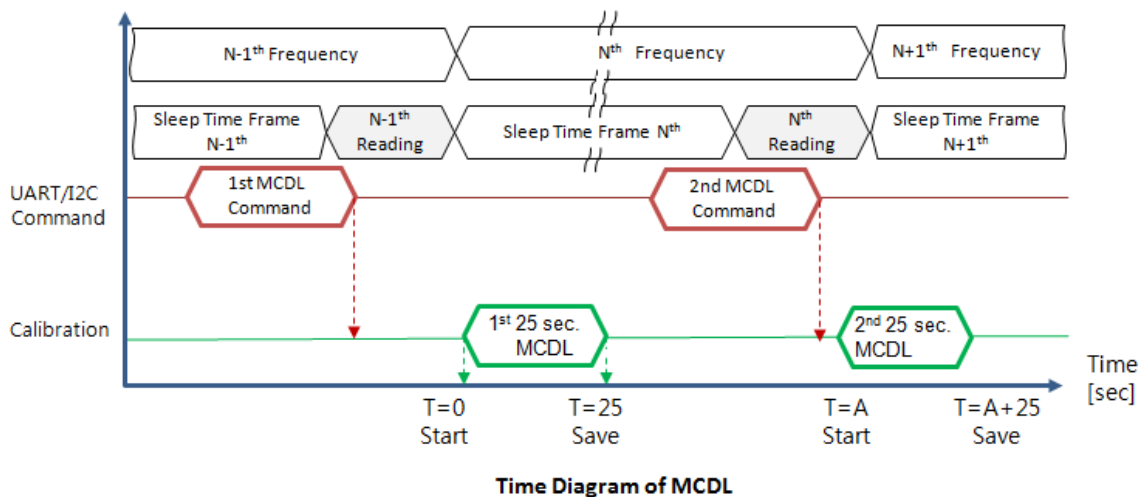

Method 1. UART Command Set; pin-3 (UART-RX) and pin-5 (UART-TX) to Main-Board.
(J2-13pin and J2-14pin are available for BtoB connector User as well)

Method 2.I2C Command Set; pin-8 (SCL) and pin-9 (SDA) to Main-Board.

Method 3.Execute Hardware based MCDL.

1. To activate ACDL function, the user's application must be designed to give Low-Active Signal topin-10 with High De-Active Signal to pin-6 for 10 minutes. Be careful to make it sure to quit MCDL fetch loop before 18minute.
(J2-6pin and J2-11pin are available for BtoB connector User as well)
2. T-110A has ACDL software in sensor, which make sensor always operate as ACDL unless MCDL is activated.
3. Be careful to make it sure to quit MCDL fetch loop before 18minute.

Method 4.Let Sensor install on Jig Board TRB-100ST (Test and Recalibration Board) with ambient air-flow condition and execute by moving jumper with Manual on the website.

Method 5.EK-100TL (Emulation kit, with Emulation program 'ELTWSO') is available, which display and save data on PC through USB connection.

Set present CO2 value with Target PPM function

1. Deviated CO2 sensors can be adjusted with target PPM function via I2C or UART interface.
(Refer to 'I2C Programming guide' or 'UART Command guide')
2. EK-100SL (Evaluation kit, with Emulation program 'ELTWSO') is available for Target PPM function.
(Refer to 'EK-100TL manual')

Sleep Mode function

1. I2C or UART commands are available to save current consumption.
(Refer to 'I2C Programming guide' or 'UART Command guide')
2. EK-100SL (Evaluation kit, with Emulation program 'ELTWSO') is available for Sleep mode.
(Refer to 'EK-100TL manual')

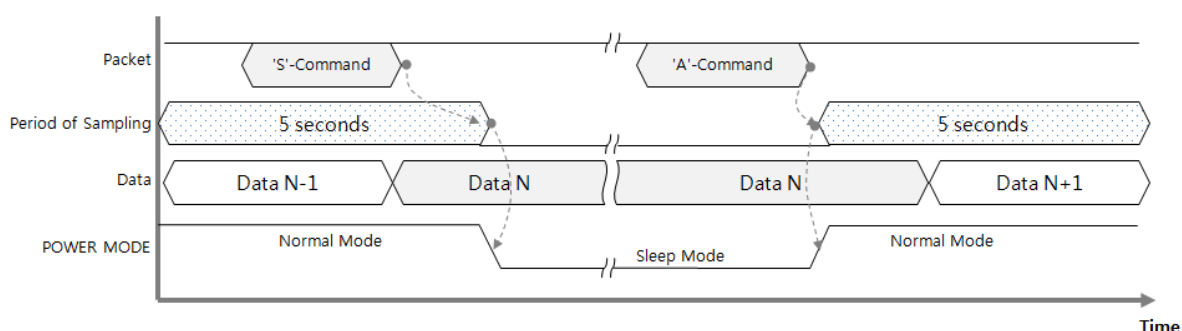

To go into the Sleep mode, Master should send Command packet to Sensor's RX-line and should be kept to 'High' until Master send the Wake-up Command to finish Sleep mode.

Sleep mode begin after 1 measurement period (1 period = 3 seconds) after getting 'Start Command' to save the current consumption. Sleep mode is finished right after the Sensor's RX-line receive the first falling edge (High -> Low) Regardless whatever the command is.

Output Descriptions

UART Descriptions

Data Format

D6	D5	D4	D3	D2	D1	SP	'p'	'p'	'm'	CR	LF
----	----	----	----	----	----	----	-----	-----	-----	----	----

D6 ~ D1	6 byte CO2 density string
SP	Space: 0x20
'ppm'	'ppm' string
CR	Carriage return : 0x0D
LF	Line feed : 0x0A

Above 12byte consist by 6 byte hexadecimal digits, <SP>, 0x70 0x70 0x6D, <CR><LF> , where decimal '0' (corresponds to hexadecimal digit '0x30') is replaced by space (corresponds to hexadecimal digit '0x20'),

EX) 1,255 ppm, results '0x20 0x20 0x31 0x32 0x35 0x35 0x20 0x70 0x70 0x6D 0x0D 0x0A', which displays '_1255_ppm<CR><LF>' on screen.

In need of detail command set, 'U-ART String Command Guide ' could be provided by contacting Sales Rep.

I2C Communication (Only Slave Mode Operation)

Internal pull up resister

Slave Address: 0x31, Slave Address Byte: Slave Address(0x31) 7 Bit + R/W 1 Bit

Bit7	Bit6	Bit5	Bit4	Bit3	Bit2	Bit1	Bit0
0	1	1	0	0	0	1	R/W Bit

R/W Bit : Read = 1/Write = 0

When reading the data, Slave Address Byte is 0x63, When writing the data, Slave Address Byte is 0x62.

ELT SENSOR Corp.

Block Diagram

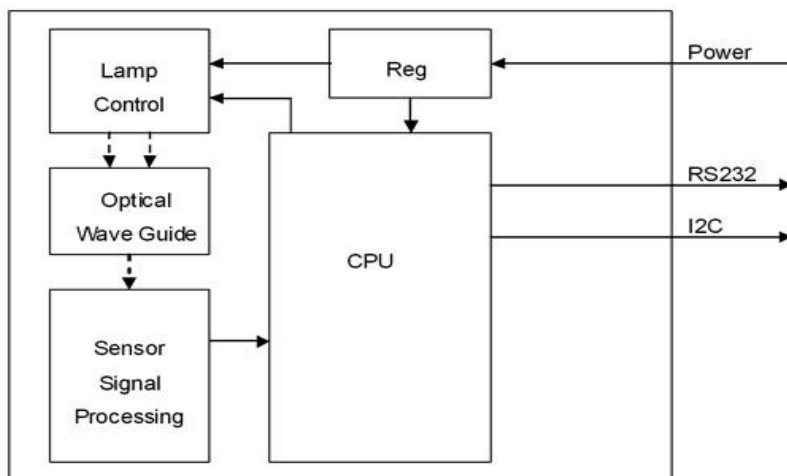

Transmission Sequence in Master

- 1) I2C Start Condition
- 2) Write Command(Slave Address + R/W Bit(0) = 0x62) Transmission and Check Acknowledge
- 3) Write Command(ASCII 'R' : 0x52) Transmission and Check Acknowledge
- 4) I2C Stop Command
- 5) I2C Start Command
- 6) Read Command(Slave Address + R/W Bit(1) = 0x63) Transmission and Check Acknowledge
- 7) Read 7 Byte Receiving Data from Module and Send Acknowledge
(Delay at least 1ms for reading each byte)

Configuration	CO ₂	reserved	reserved	reserved	reserved
1 Byte	2 Byte	0x00	0x00	0x00	0x00

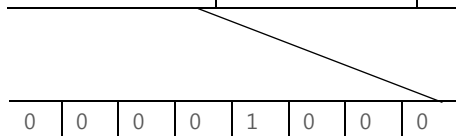

In need of detail protocol specification and time sequence, 'I2C programming guide' could be provided by contacting Sales Rep.

Analog Voltage Output Descriptions (Option)

Measured Voltage 0.5V~3.0V match proportionally to 0~ 2,000 each for 2,000 ppm scale sensor and any of 0~3,000 or 5,000 or 10,000 ppm scale sensor could be set by designating on sale. There fore 3.0V will match 2,000 or 3,000 or 4,000 or 10,000 ppm or 2% or 3% or 5% or 10% each.

* CO2 Measurement_(ppm) = ((Output Voltage- 0.5) / (3.0- 0.5)Voltage) x F.S. ppm ,
 cf.F.S. (ppm) : 2,000/3,000/5,000/10,000 ppm (20,000/30,000/50,000/100,000 is optional.)

EX) if the Output Voltage is 2.5V in 2,000 ppm (F.S. of Reading range)

$$\text{CO2 Measurement}_{\text{ppm}} = (2.5 - 0.5) \text{ V} \div (3.0 - 0.5) \text{ V} \times 2,000. \text{ ppm}$$

$$= 2 \div 2.5 \times 2,000 \text{ ppm} = 1,600 \text{ ppm}$$

PWM Descriptions (Option)

- * Measurement_(ppm) = (t_H-2msec)/1000msec x Range_(ppm) (t_H : High Pulse Width)
- * Range_(ppm) : 2,000/3,000/5,000/10,000 ppm (20,000/30,000/50,000/100,000 is optional.)

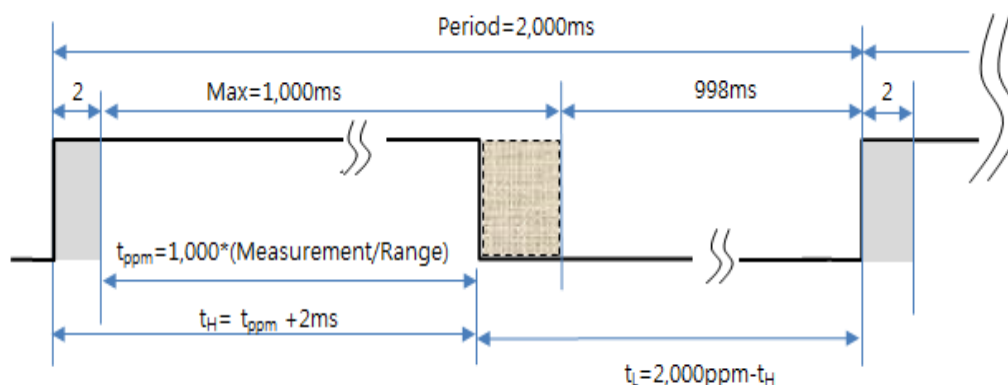

EX) t_H(High Pulse Width) calculation for 400ppm in 2,000 ppm Range.

*Measurement_(ppm) = 400 ppm = (t_H-2ms)/2,000msec x Range_(ppm) ,

*t_H= 1,000 msec * (400 ppm / 2,000ppm) + 2msec = 202msec

(cf: T_L= Period - t_H = 2,000ppm - 202 msec = 1,798 msec.)

※ Caution

1. Please hold only 'PCB' of sensor without holding Cavity directly to avoid the physical shock on sensor. Rough handling or Transportation could result in inaccurate reading.
2. Proper ESD protection during handling is important to avoid electrostatic defect occurrence.
The storage of sensor should be insulated as well

ELT SENSOR Corp.

ChunuiTechnopark 101-909)36,
Bucheon-ro 198beon-gil, 2015

Wonmi-gu, Bucheon-si, Gyeonggi-do, 420-857, Korea
Phone. +82-32-719-8055, <http://www.eltsensor.co.kr>

Subject to change without notice. Printed in KOREA
ELT Sensor All rights reserved.
2016. DEC