

General

Version 1.1

H-250(G)-3V is one of the smallest CO₂ sensor modules in the world which measures high concentration CO₂ ranges (0~25%). Its Persistent Stability and Temperature Effect Resistance besides easy management are much favored by customers in CA Storage, Greenhouse, scientific projects, etc.

ELT Sensor Data Sheet for H-250(G)-3V

Features

- Non-Dispersive Infrared (NDIR) technology used to measure CO₂ levels.
- Pre-calibrated
- Available outputs : TTL-UART, I2C, Alarm
(PWM / Analog Voltage : option)
- Gold-plated sensor provides long-term calibration stability.
- Installed re-calibration function
- Non-Periodic Manual Re-Calibration (MCDL) are available. (Calibration with 0ppm or 400ppm CO₂ gas)
- Size : 32.5mmx38mmx19.1mm
- Weight : 10 grams



H-250(G)-3V Specifications

General Performance

Operating Temperature : -10 ~ 60 °C

Operating Humidity : 0 ~ 95% RH (Non-condensing) , 'G' option : 0 ~ 99% RH (Non-condensing)

Operating Environment : Incubators, CA Storages, Industry fields etc.

Storage Temperature : -30°C ~70°C

CO₂ Measurement

Sensing Method : NDIR (Non-dispersive Infrared)

Measurement Range : 0 ~ 25% (0~5%/10%/15%/20% models are available)

Accuracy : ±(300ppm+3%) of reading ⁽¹⁾⁽²⁾

Step Response Time (T90) : 2 minutes

Sampling Interval: 3 seconds

Warming-up Time : < 6 seconds (for Operation), 5 minutes (for Accuracy)

Electrical Data

Power Input : 3.3V (3.2V~3.6V) ⁽³⁾

Connectors : 4pin B-to-B con. or 13pin Side hole

Current Consumption : Normal mode : 10mA, Peak < 228mA

Product Derivatives and Relative Functions

Products	Option List
H-250-3V	UART,I2C, ALARM. (Analog Voltage or PWM is optional), 0_MCDL, 400_MCDL
H-250G-3V	Resistance up to 99% Humidity for Application of Green House

H-250(G)-3V has various output TTL-UART, I2C and ALARM while as PWM / AVO is selectable as option. 2.54pitch 13pin side holes and 2mm pitch 10 and 4pin 2 row header connector are available. Manual Calibration (10' MCDL) are executable by sending 'Low Signal' to pin-11 and pin-13 of J13.

(1) Periodical MCDL is recommended to keep accuracy.

(2) Air pressure is assumed as 101.3 kPa

(3) DC Supply should be regulated , low noise power source for best accuracy

Pin Map with J11&J12 Connectors

J-11	Description	
1/3	VDD (+3.3V VCC)	
2/4	GND	

J-12	H-250(G)-3V	H-250(G)-3V (Analog Voltage Option)
1	TTL RXD (← CPU of Master Board)	
2	TTL TXD (→ CPU of Master Board)	
3	I2C SCL	
4	I2C SDA	
5	GND	
6	Reserved	Analog Voltage Output (0.5~3.0V)
7	CAL 2: CO2 0 ppm Manual Calibration (0_MCDL, 10 min.)	
8	Reserved	
9	CAL 1: CO2 400 ppm Manual Calibration (400_MCDL, 10 min)	
10	Reset (Low Active)	

UART (J-12:P1&P2) : 38,400BPS, 8bit, No parity, 1 stop bit

I2C (J-12:P3&P4) : Slave mode only, Internal pull up resistor (10kΩ)
 TTL Level Voltage : $0 \leq V_{IL} \leq 0.4, 2 \leq V_{IH} \leq V_{DD}, 0 \leq V_{OL} \leq 0.4, 2.4 \leq V_{OH} \leq V_{DD}$ (Volt)

ALARM (Open Collector type)

10,000 ppm ≤ Alarm ON, 8,000 ppm ≥ Alarm OFF and alarming range can be change by EK-100SL with connected to PC.

Option 1 : Analog Voltage(J-12:pin-6, J-13:pin-1) : 0.5~3.0 V.

Option 2 : PWM (J-13:pin-7 is available) In case the PWM option is chosen,

$$t_H = 2 \text{ msec (Start)} + 1,000 \text{ msec} \times (\text{Measurement}_{(\text{ppm})} / \text{Range}_{(\text{ppm})}), T_L = 2,000 \text{ ms} - t_H,$$

Pin Map with J13 Connectors

J-13	H-250(G)-3V	H-250(G)-3V (Analog Voltage, PWM Option)
1	Reserved	Analog Voltage Output (0.5~3.0V)
2	Alarm (Open Collector)	
3	GND	
4	VDD (+3.3V VCC)	
5	TTL TXD (→ CPU of Master Board)	
6	TTL RXD (← CPU of Master Board)	
7	Reserved	PWM Output
8	I2C SCL	
9	I2C SDA	
10	Reset (Low Active)	
11	CAL 2: CO2 0 ppm Manual Calibration (0_MCDL, 10 min.)	
12	Reserved	
13	CAL 1: CO2 400 ppm Manual Calibration (400_MCDL, 10 min)	

Cavity Dimensions (unit : mm)

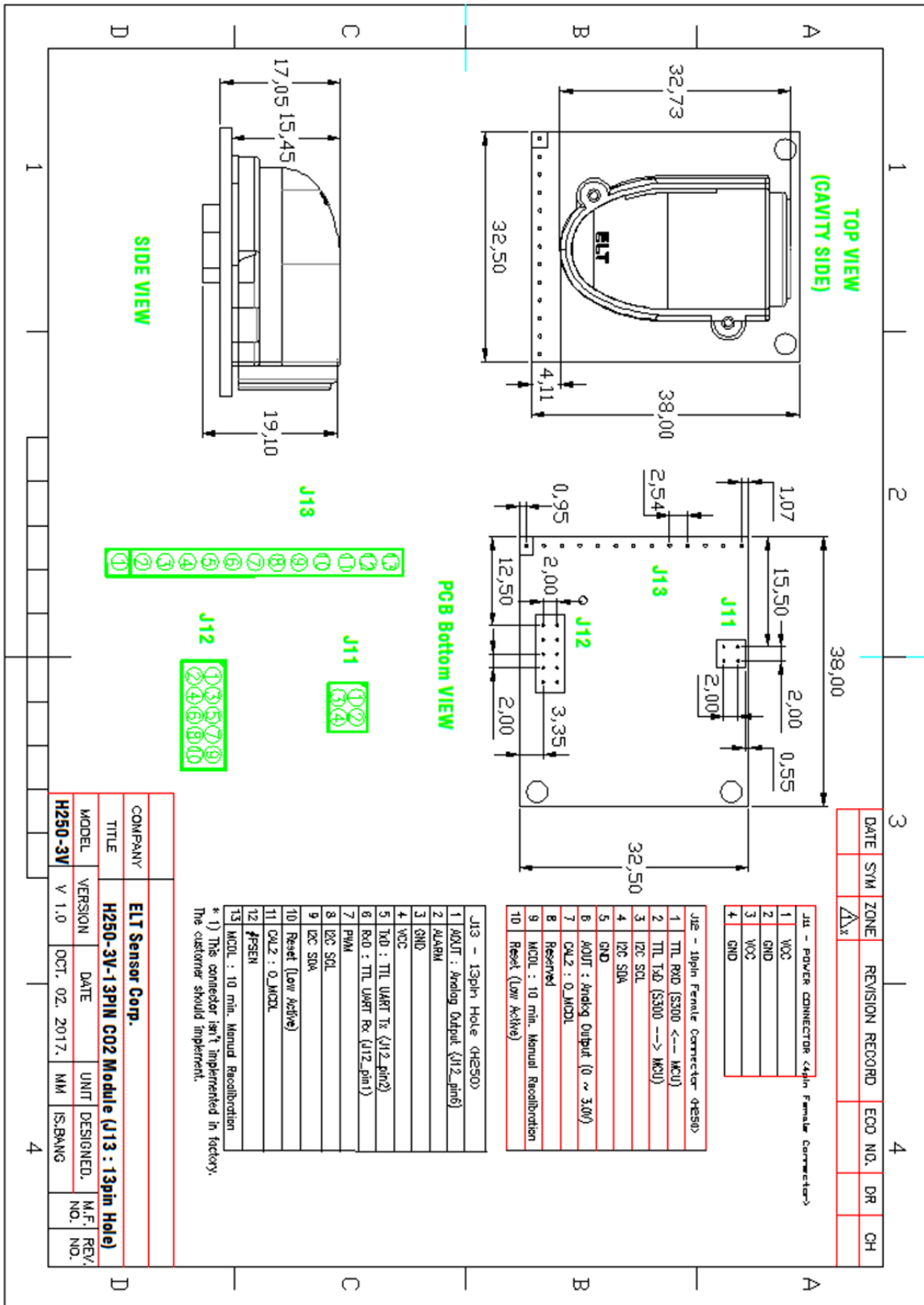

COMPANY	ELT Sensor Corp.			
TITLE	H250-3V-13PIN CO2 Module (J13 : 13pin Hole)			
MODEL	VERSION	DATE	UNIT	M.F. REV.
H250-3V	V 1.0	OCT. 02. 2017.	MM	NO. NO.
			IS.BANG	

10' MCDL function (10 minute Manual Calibration Function in Dimming light)

※ H-250(G)-3V : MCDL enable customer to calibrate as needed, MCDL keep at least 10 minute once it start and should be stopped before 18minute to avoid MCDL fetch repetition.

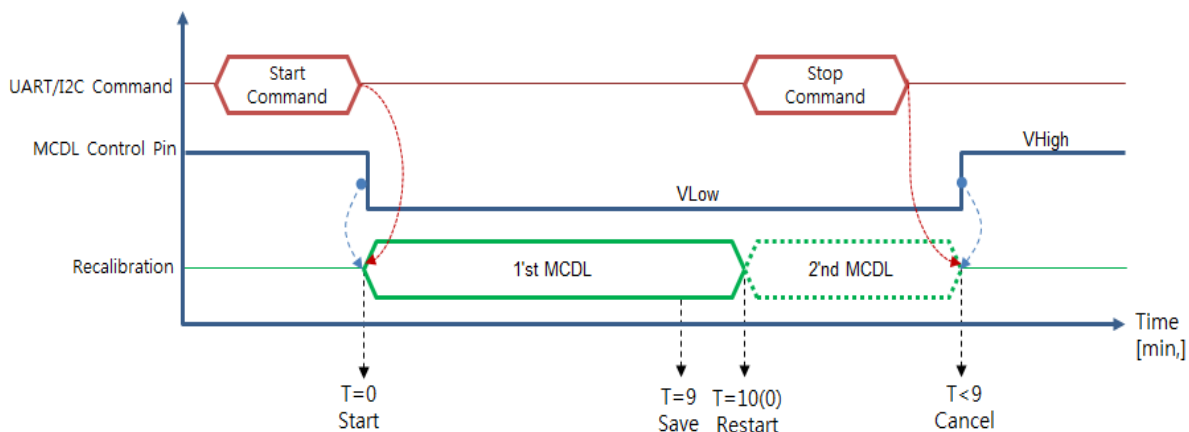

Time Diagram of MCDL

Method 1. UART Command Set ; J12: pin-1 (UART-RX) and pin-2 (UART-TX) to Main-Board.
(J13: pin-6 and pin-5 are available as well)

I2C Command Set; J12: pin-3 (SCL) and pin-4 (SDA) to Main-Board.
(J13: pin-8 and pin-9 are available as well)

Method 2. For PWM or AVO (Analog Voltage Output), Hardware based MCDL setting is available.

Status	0_MCDL (J12:7 or J13:11)	400_MCDL (J12:9 or J13:13)	Notes
CAL 1 (H/W 0_MCDL)	Low	High	Sensor should be located in 0ppm environment (outside) for 10 minutes
CAL 2 (H/W 400_MCDL)	High	Low	Sensor should be located in 400ppm environment (outside) for 10 minutes
None	High	High	Factory Calibration Status or Last Calibrated Status

- ※ 1. (J12:pin-7 or J13:pin-11) and (J12:pin-9 or J13:pin-13) shouldn't have 'Low' at any time.
- 2. Be sure to quit MCDL fetch loop before 18minute.

Method 3. Let Sensor install on Jig Board, **TRB-100ST (Test and Recalibration Board)** with ambient air-flow condition and execute by moving jumper following Manual on the website.

Method 4. **EK-100SL (Evaluation kit, with Emulation program ‘ELTWSO’)** is available, which display and save data on PC through USB connection.

*** Set present CO2 value with Target PPM function**

1. Deviated CO2 sensors can be adjusted with target PPM function via I2C or UART interface. (Refer to ‘I2C Programming guide’ or ‘UART Command guide’)
2. EK-100SL (Evaluation kit, with Emulation program ‘ELTWSO’) is available for Target PPM function. (Refer to ‘EK-100SL manual’)

Output Descriptions

- * UART : Output unit of measured value is PPM or Percent(%).
- I2C : Output unit of measured value is PPM or Percent(%).
- But, I2C gives the data as below ;
- PPM = Measured value x 100, Percent(%)= Measured value / 100

UART Descriptions

Data Transmit

Interval : 3 seconds, Handshake protocol : None (Data is transmitted to outer device periodically)

Data Format

1. % (percent)

D4	D3	●	D2	D1	SP	'%'	CR	LF
----	----	---	----	----	----	-----	----	----

D4 D3 ● D2 D1	CO2 density string
SP	Space: 0x20
'%'	'%' : 0x25
CR	Carriage return : 0x0D
LF	Line feed : 0x0A

Above 9 byte consist by 5 byte hexadecimal digits, <SP>, 0x25, <CR> <LF> , where decimal '0' (corresponds to hexadecimal digit '0x30') is replaced by space (corresponds

to hexadecimal digit '0x20') for lower value than 10%.

EX) 0.08%, results in '0x30 0x2E 0x30 0x38 0x20 0x25 0x0D 0x0A', which displays '0.08_%<CR><LF>' on screen. 5% corresponds '0x35 0x2E 0x30 0x30 0x20 0x25 0x0D 0x0A', which displays '5.00_%<CR><LF>', 15% gives '0x31 0x35 0x2E 0x30 0x30 0x20 0x25 0x0D 0x0A', which displays '15.00_%<CR><LF>'.

2. ppm (part per million)

D6	D5	D4	D3	D2	D1	SP	'p'	'p'	'm'	CR	LF
D6 ~ D1						6 byte CO2 density string					
SP						Space: 0x20					
'ppm'						'ppm' string					
CR						Carriage return : 0x0D					
LF						Line feed : 0x0A					

Above 12byte consist by 6 byte hexadecimal digits,<SP>,0x70 0x70 0x6D, <CR><LF> , where decimal '0' (corresponds to hexadecimal digit '0x30') is replaced by space (corresponds to hexadecimal digit '0x20'),

EX) 1,255 ppm, results '0x20 0x20 0x31 0x32 0x35 0x35 0x20 0x70 0x70 0x6D 0x0D 0x0A', which displays '_1255_ppm<CR><LF>' on screen.

I2C Communication (Only Slave Mode Operation)

Internal pull up resistor

Slave Address: 0x31, Slave Address Byte: Slave Address(0x31) 7 Bit + R/W 1 Bit

Bit7	Bit6	Bit5	Bit4	Bit3	Bit2	Bit1	Bit0
0	1	1	0	0	0	1	R/W Bit

R/W Bit : Read = 1/Write = 0

When reading the data, Slave Address Byte is 0x63, When writing the data, Slave Address Byte is 0x62.

Block Diagram

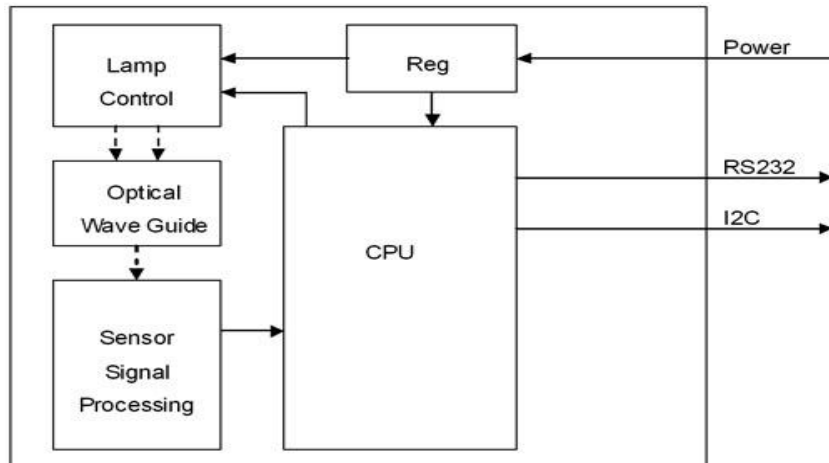

Transmission Sequence in Master

- 1) I2C Start Condition
- 2) Write Command(Slave Address + R/W Bit(0) = 0x62) Transmission and Check Acknowledge
- 3) Write Command(ASCII 'R' : 0x52) Transmission and Check Acknowledge
- 4) I2C Stop Command
- 5) I2C Start Command
- 6) Read Command(Slave Address + R/W Bit(1) = 0x63) Transmission and Check Acknowledge
- 7) Read 7 Byte Receiving Data from Module and Send Acknowledge
(Delay at least 1ms for reading each byte)

Configuration	CO ₂	reserved	Reserved	reserved	reserved
1 Byte	2 Byte	0x00	0x00	0x00	0x00

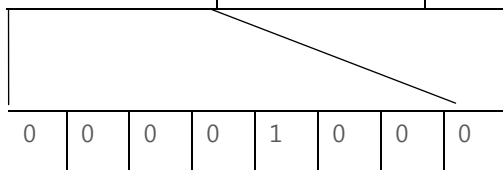

Sensors give 1/100 ppm of measurement which correspond to 100 times of percent.

For % (percent) output, the measured value should be used after division by 100.

EX) if measured value is 1,250, it is 12.5% (1,250/100 = 12.5%).

For ppm output, the measured value should be used after multiplication by 100.

EX) if measured value is 1,250, it is 125,000ppm (1,250*100 = 125,000ppm).

In need of detail protocol specification and time sequence, I2C programming guide is capable of providing through Sales Rep.

Analog Voltage Description ; Option

* Measurement(% or ppm) : 0.5~3.0V

Measured Voltage 0.5V~3.0V matches proportionally to 0 ~ 5%(50,000ppm), 10%(100,000ppm), 15%(150,000ppm), 20%(200,000ppm), 25%(250,000ppm)

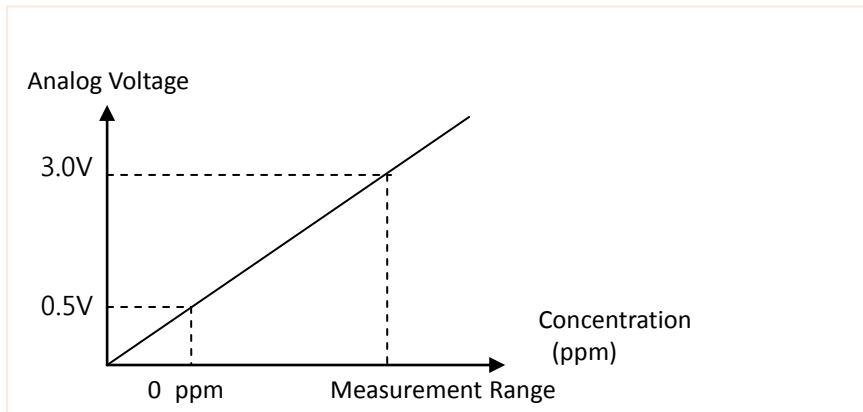

* CO2 Measurement (%) = $\frac{(\text{Output}_{\text{voltage}} - 0.5)}{(3.0 - 0.5)_{\text{voltage}}} \times \text{F.S. \%}$,

cf. F.S. % : 5% / 10% / 15% / 20% / 25%

EX) if the Output_{voltage} is 2.5V in 20% (F.S. of Reading range)

$$\begin{aligned} \text{CO2 Measurement}(\%) &= \frac{(2.5 - 0.5) \text{ V}}{(3.0 - 0.5) \text{ V}} \times 20\% \\ &= (2 \div 2.5) \times 20\% = 16\% \end{aligned}$$

* CO2 Measurement (ppm) = $\frac{(\text{Output}_{\text{voltage}} - 0.5)}{(3.0 - 0.5)_{\text{voltage}}} \times \text{F.S. (ppm)}$,

cf. F.S. (ppm) : 50,000 / 100,000 / 150,000 / 200,000 / 250,000 ppm

EX) if the Output_{voltage} is 2.5V in 200,000 ppm (F.S. of Reading range)

$$\begin{aligned} \text{CO2 Measurement ppm} &= \frac{(2.5 - 0.5) \text{ V}}{(3.0 - 0.5) \text{ V}} \times 200,000 \text{ ppm} \\ &= (2 \div 2.5) \times 200,000 \text{ ppm} = 160,000 \text{ ppm} \end{aligned}$$

PWM Descriptions ; Option

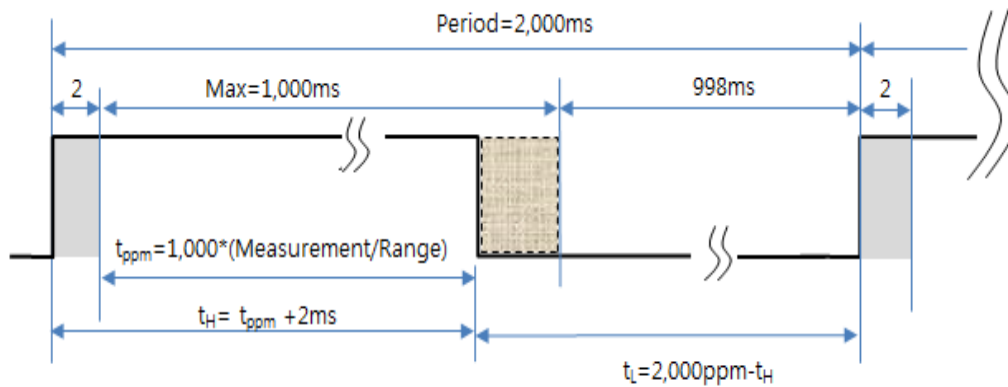

* $Measurement_{(ppm)} = (t_H - 2msec) / 1000msec \times Range_{(ppm)}$ (t_H : High Pulse Width)

* $Range_{(ppm)}$: 2,000/3,000/5,000/10,000 ppm (20,000/30,000/50,000/100,000 is optional.)

EX) t_H (High Pulse Width) calculation for 5% in 10% Reading range.

* $Measurement_{(ppm)} = 5\% = (t_H - 2ms) / 2,000msec \times Reading\ range_{(ppm)}$,

* $t_H = 2,000\ msec \times (5\% / 10\%) + 2msec = 1,002msec$

(cf: $T_L = Period - t_H = 2,000\ ppm - 1,002\ msec = 998\ msec.$)

EX) t_H (High Pulse Width) calculation for 4,000 ppm in 50,000 ppm Range.

* $Measurement_{(ppm)} = 4,000\ ppm = (t_H - 2ms) / 2,000msec \times Range_{(ppm)}$,

* $t_H = 2,000\ msec \times (4,000\ ppm / 50,000\ ppm) + 2msec = 162msec$

(cf: $T_L = Period - t_H = 2,000\ ppm - 162\ msec = 1,840\ msec.$)

Alarm Descriptions

Alarm is Open Collector type which work SPST (Single Pole Single Throw). Alarm is 'OFF' status at first and turn to 'ON' status since CO2 value go beyond 10,000ppm until it go down to 8,000ppm to avoid unwanted rapid switching by hysteresis effect.

10,000 ppm ≤ Alarm ON, 8,000 ppm ≥ Alarm OFF

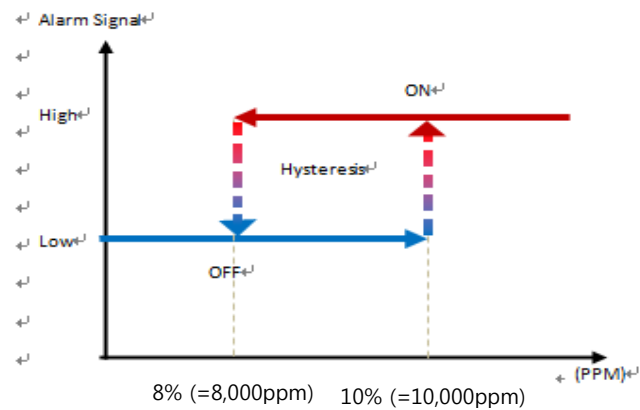

EK-100SL series is available for customer to enable to change alarm activation & deactivation point.

※ Caution

1. Please hold only 'PCB' of sensor without holding Cavity directly to avoid the physical shock on sensor. Rough handling or Transportation could result in inaccurate reading.
2. Proper ESD protection during handling is important to avoid electrostatic defect occurrence. The storage of sensor should be insulated as well.

※ Specification of H-250 Series could be changed without notice.